

# Demodulating with the LMX2240 150 MHz IF Receiver

National Semiconductor  
Application Note 1020  
Wireless Communications  
December 1995



Demodulating with the LMX2240 150 MHz IF Receiver

## SUMMARY

The applications for the LMX2240 IF Receiver are discussed. Practical limitations of high frequency IF demodulators are examined, and methods to cope with these limitations are introduced. Specifically, methods to reduce the susceptibility to oscillation are given, and include layout considerations as well as circuit implementations. In addition, the demodulator tank circuit is examined in detail, and three configurations for the tank circuit are given. Theoretical derivations and plots for the tank circuits are presented, as well as measured results. The measured results agree well with the theoretical predictions.

## INTRODUCTION

The LMX2240 Intermediate Frequency Receiver allows radio designers to implement high IF, single conversion receivers. This type of receiver is critical in cost driven, consumer markets such as the Digital European Cordless Telecommunications (DECT) system, 2.4 GHz–2.48 GHz wireless local area networks (WLANs), and the 902 MHz–928 MHz Industrial, Scientific, and Medical (ISM) band cordless telephones in the United States. An important consideration in these single conversion receivers is the IF Receiver, or IF strip. This circuit must have high gain ( $>70$  dB) at high frequencies (150 MHz), and still remain stable. These conflicting demands result in an integrated circuit that can oscillate if proper circuit design and layout are not followed.

This application note will examine two major topics: practical circuits to reduce the chance of oscillation in the LMX2240, and practical implementation of tank circuits. The second section describes some simple means of detecting oscillation and presents layout and circuit solutions to remove oscillation. The third section derives quadrature tank circuit configurations, and plots their responses. Included in this section are measured S-curve plots and demodulated sine waves using the various configurations. Finally, some conclusions will be drawn.

## OSCILLATION

While oscillation is never a desired effect in radio receivers, it is sometimes easy to create. As this paper will illustrate, with proper board layout, the LMX2240 can be used effectively with no oscillation.

## DETECTING OSCILLATION

There are several ways of detecting whether, in fact, the LMX2240 is oscillating. One technique uses the RSSI output of the device, an RF signal generator, and a voltmeter or oscilloscope. This is illustrated in *Figure 1(a)*.

The user inputs an unmodulated carrier frequency to the IF In pin (16), and measures the output voltage of the RSSI circuit (pin 2). The input power level of the RF signal generator should be changed so that the RSSI curve in the Typical Performance Characteristics section of the LMX2240 data sheet (Lit. # 108540-002) is followed. This will usually mean input levels of 0 dBm through  $-80$  dBm at pin 16. If the part is oscillating, the RSSI curve will flatten at some point above the proper point according to the data sheet. The slope will change at the lower end of the curve as well.

The point at which the RSSI curve levels is a good indication of the power level of the oscillation tone. For example, if the curve levels at  $-75$  dBm input power, it is likely that the oscillating tone is also at about that power. If, however, the curve levels at  $-20$  dBm, it is indicative of a high power tone oscillation.

Another technique for determining oscillation is to examine the output spectrum of the limiter using a resistive probe kit or other high impedance probe (a series  $R = 1000\Omega$  will work, too). This is illustrated in *Figure 1(b)*. As the power level of the input signal is reduced, the power level of the oscillation tone will tend to increase as the limiter suppression is less dominating. Eventually, the desired carrier frequency will reduce to the noise floor, and the oscillation tone will be present.

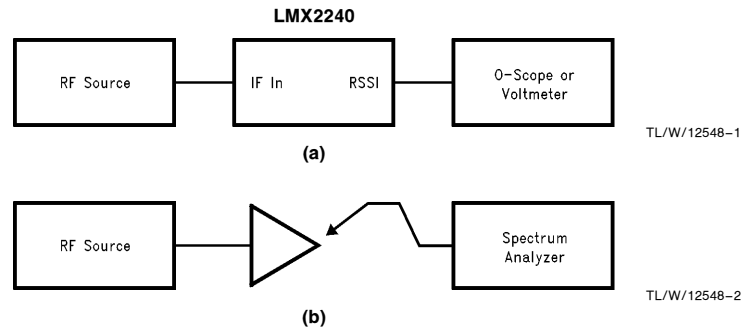

FIGURE 1. Lab Measurement Systems for Detecting Oscillation in the LMX2240

AN-1020

It should be noted that oftentimes the probe itself will introduce oscillations. Therefore, the designer must be careful to probe a ground near the LMX2240 as well as the output of the limiter to confirm that the limiter is indeed oscillating. A good practice is to probe the limiter output while monitoring the RSSI output. If the RSSI output jumps when the probe is touched to the limiter output, it is likely that the probe is causing oscillation. Multiple probings of grounds and components near the LMX2240 will help to confirm whether there is, in fact, an oscillation problem or if the action of probing is causing oscillation.

#### REMOVING OSCILLATION

Once it has been established that oscillation is occurring, the next step is to remove it. Several options are available to do this, and they may be used separately or together, depending on the severity of the oscillation. It is important to note that the best way to remove oscillation is to have a clean, well-planned circuit board layout that separates the quadrature tank from other resonant elements such as surface acoustic wave (SAW) filters. A layout for the revision F evaluation board for the LMX2240 is shown in *Figure 2*.

This layout has many of the properties for proper layout. The entire LMX2240 is over solid ground plane, as is the tank circuit. Top side ground plane has not been included, but certainly could be. The quadrature tank is separated from the SAW filter, and in fact can be shielded if necessary. The compensation capacitors on pins 14 and 15 are as close as possible to the device, and have very little trace between them. This reduces stray board capacitance and inductance. Similarly, the tank circuit is connected through short traces and is close to the LMX2240. In general, it is best to have the tank circuit and SAW filter separated physically as much as possible, either on two sides of the board (with middle ground plane) or at two ends of the LMX2240, as on the rev. F evaluation board.

In addition to a good board layout, the supply lines should be properly decoupled. This is shown in the application circuit in the data sheet, and is repeated here. The decoupling capacitors should be as close to the LMX2240 as possible, and should have small traces to ground. In some cases, dual bypass capacitors at each  $V_{CC}$  pin, one small value and one larger value, might be necessary. Typically, however, the simple 100 pF/0.01  $\mu$ F bypass capacitors are sufficient. Pads for these are shown in *Figure 2*.

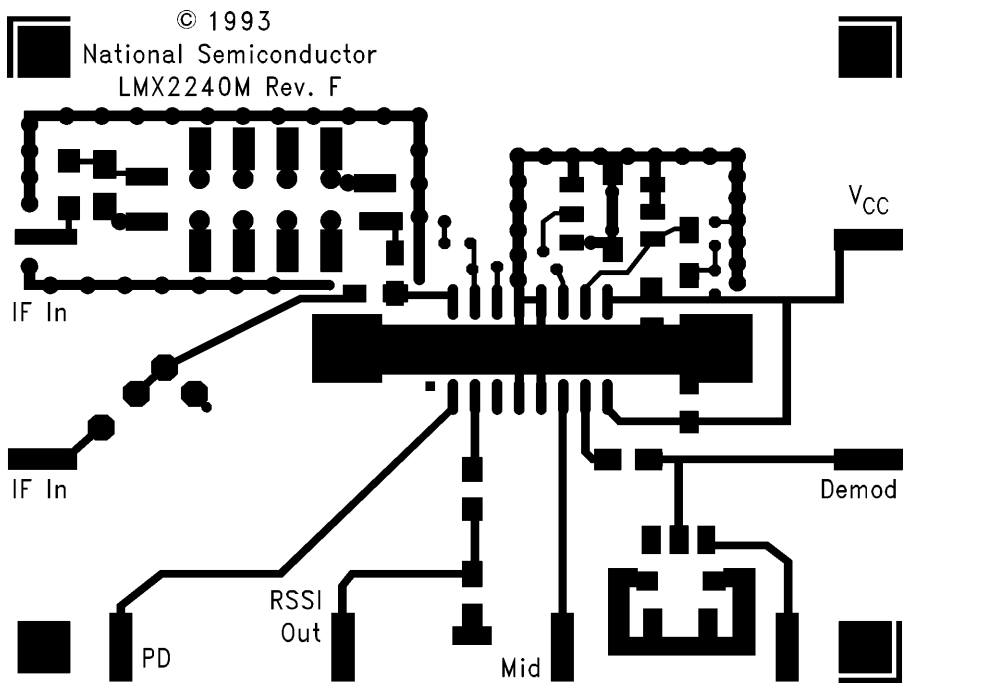
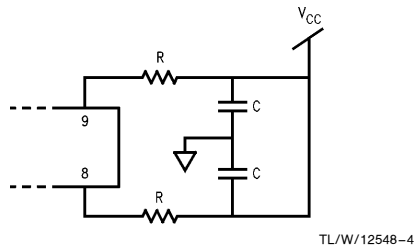

FIGURE 2. Plot of LMX2240 Revision F Evaluation Board Top Layer Metal

Proper decoupling and good board layout will solve 95% of oscillation problems. However, for those cases that still have oscillation with the above precautions taken, there are additional solutions. The most effective of these is a small valued resistor placed in series with the  $V_{CC}$  line. It should be placed between the  $V_{CC}$  pins (8 and 9) and the decoupling capacitors. A  $27\Omega$  resistor for each  $V_{CC}$  pin is a good choice. No less than  $18\Omega$  and no greater than  $39\Omega$  should be used, since the lower values may be ineffective, and higher values than 39 will cause significant  $V_{CC}$  drop from the RF supply. A schematic is shown in *Figure 3*.



**FIGURE 3. Schematic of  $V_{CC}$  Filtering to Eliminate Oscillations**

Another technique that is effective is placing a small resistor in the feedback path (between pins 14 and 15). This resistor will effectively attenuate the high frequency components of the feedback by placing a finite pole. It also reduces gain of the device by several dB. Typically, a  $12\Omega$  resistor will reduce gain by about 3 dB, and a  $25\Omega$  resistor will reduce gain by about 6 dB. It is not recommended to go beyond a  $39\Omega$  resistor in the feedback path. A circuit diagram is shown in *Figure 4*.

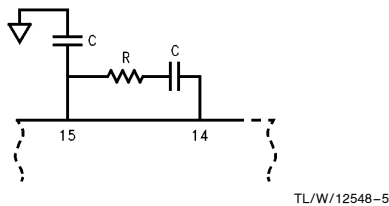

**FIGURE 4. Circuit Diagram for Feedback Resistor**

The LMX2240 operates well when driven from a real impedance. If a particular SAW filter is especially capacitive, it may be necessary to insert a small pad between the SAW filter and the LMX2240 to present a real impedance to the LMX2240 input. A 3 dB or 6 dB pad should be sufficient, and it can be either a pi or tee configuration. This is shown in *Figure 5*. Since introducing loss (and noise) is undesirable, the designer should first inspect board layout and decoupling before resorting to the pad.

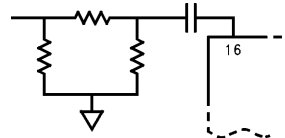

**FIGURE 5. Circuit Diagram for the Input Pad (pi Pad Shown)**

A final step with even less desirable side effects will be discussed in detail in the tanks section, but will be noted here. This involves placing a small load capacitor on the output of the limiter. This places a low pass pole on the limiter and adds to the roll-off of higher frequency components, eliminating oscillations. However, it also affects the tank circuit's signature curve (S-curve) by flipping the phase at the normal zero crossing.

#### LIMITER PERFORMANCE

The limiter can be used with various compensation capacitors, and the choice of compensation capacitors is driven by the frequency of operation. A plot of limiter gain vs frequency with compensation capacitor value as a parameter for a typical LMX2240 device is given in *Figure 6*. It can be seen that as the compensation capacitor values are increased, the pass band becomes wider. For high IF operation (i.e., 110 MHz), the compensation capacitors should be 100 pF to get the narrowest pass band.

**LMX2240 Gain vs Frequency with Compensation Capacitors as a Parameter**

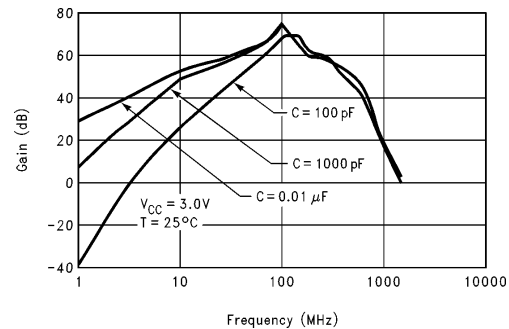

**FIGURE 6. Plot of LMX2240 Limiter Gain vs Frequency**

#### QUADRATURE TANK CIRCUITS

The design of good quadrature tank circuits is critical to the successful use of high IF limiter-discriminator integrated circuits. A good quadrature tank circuit uses few components while still achieving significant phase shift across the band of interest. Since most digital communication systems use narrow channel bandwidths, a high IF limiter-discriminator requires higher than average phase shift (hence, higher Q). This application note will focus on the use of high Q, single tank circuits. A derivation for dual tuned tank circuits can be found in [1].

## PARALLEL TANK

The basic tank circuit uses a configuration as shown in *Figure 7*. The principle of operation for a tank circuit is that coupling capacitor C1 introduces a constant 90° phase shift to create quadrature, and the resonant circuit provides instantaneous phase shifts that correspond to changes in the modulation. The multiplication of these in the mixer then provide the output demodulated signal. The theory of operation of discriminators is included in the LMX2240 Data Sheet [2].

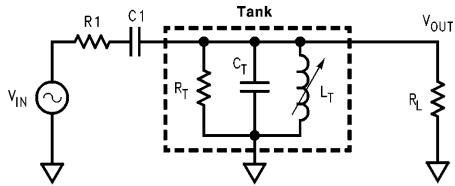

TL/W/12548-8

**FIGURE 7. Typical Application Circuit for the LMX2240 using Conventional Tank Circuit**

The operation of the conventional tank circuit is derived in [1], and only the results are given here. Examining *Figure 7* and converting it to a Norton equivalent circuit, it can be seen that the transfer function  $H(j\omega)$  is given by the impedance of the tank circuit (if R1 is neglected):

$$H(j\omega) = \frac{-\omega^2 C_1 L_T R_T}{R_T(1 - \omega^2 L_T(C_T + C_1)) + j\omega L_T} \quad (1)$$

It has been shown in [1] that the resultant phase characteristic of  $H(j\omega)$  is given by

$$\phi = \arctan\left[\frac{\gamma}{(\gamma^2 - 1)Q_o}\right] \quad (2)$$

with

$$\gamma = \frac{\omega}{\omega_o} \quad (3)$$

$$\omega_o^2 = \frac{1}{L_T(C_T + C_1)} \quad (4)$$

$$Q_o = \frac{R_T}{\omega_o L_T} \quad (5)$$

*Figure 8(a)* shows a plot of the phase and magnitude of equation (2), and *Figure 8(b)* shows the measured signature curve (S-curve) of an LMX2240 that uses this type of tank circuit. An S-curve is a plot of the phase characteristic of a discriminator that is generated by sweeping an unmodulated carrier across the frequency band of the discriminator and measuring the output of the mixer. The S-curve gives an indication of the linearity and total phase shift of the discriminator.

Component values used for the plots are  $C_1 = 4.7$  pF,  $R_1 = 250\Omega$ ,  $R_T = 1000\Omega$ ,  $C_T = 13.5$  pF,  $L_T = 150$  nH,  $R_L = 30$  k $\Omega$ . Good agreement between the theoretical curve and the measured curve is shown. Also, it should be noted that the phase shift for a typical DECT signal (576 kHz peak-to-peak frequency deviation at 110.592 MHz) is about 45°, leading to an output eye diagram of about  $1.2V \cdot (45/180) = 300$  mVpp (*Figure 9*). *Figure 9* shows the output of a demodulated 1 kHz tone with 200 kHz peak frequency deviation, and the 260 mVpp shows the 89% eye opening typical of Gaussian  $B_p T = 0.5$  filtering.

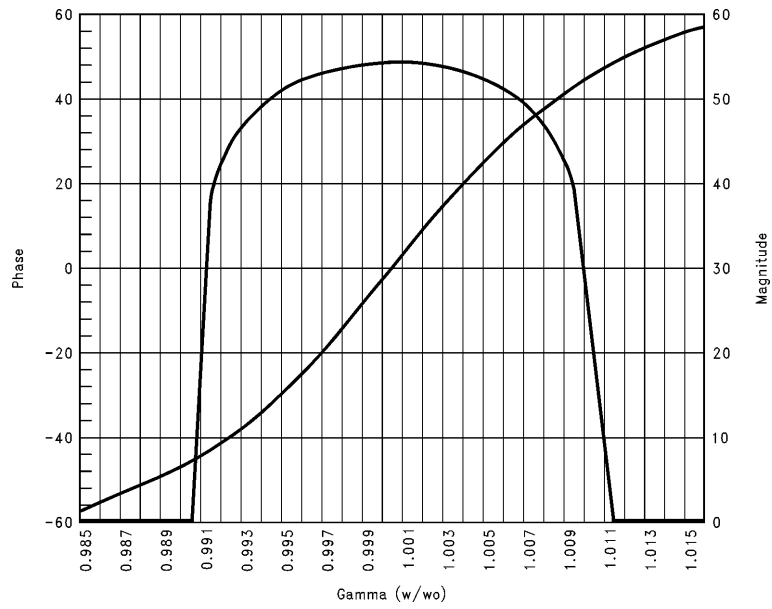

(a)

TL/W/12548-9

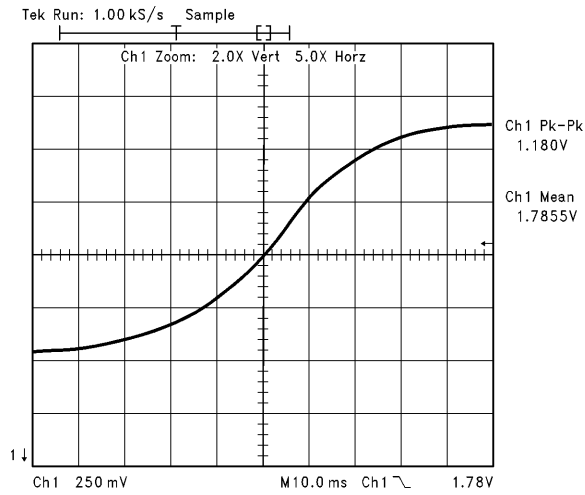

(b)

TL/W/12548-10

**FIGURE 8. Plot of conventional parallel tank circuit. (a) Theoretical phase and magnitude (b) Measured phase characteristic (S-curve). Horiz. - 725 kHz/div., vert. 250 mV/div.**

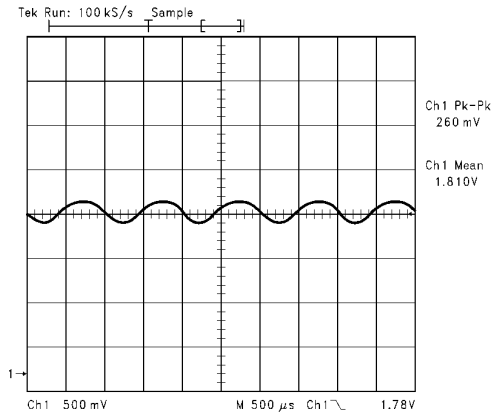

**FIGURE 9. Plot of Received “Eye Diagram” for 1 kHz Tone with 200 kHz Peak Deviation Using the Conventional Parallel Tank Circuit**

**PARALLEL TANK WITH LOAD CAPACITOR**

A radical solution to reduce oscillations in the LMx2240 is to introduce a load capacitor at the output of the limiter. This has the effect of reducing the amplitude of the higher frequency components the limiter generates, thus reducing their effect in the feedback loop. However, the load capacitor also changes the phase characteristic of the tank circuit.

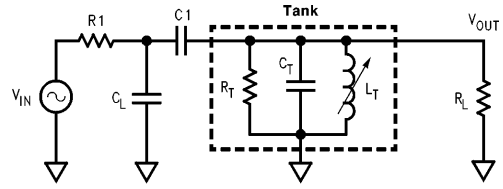

**FIGURE 10. Circuit Diagram for Parallel Tank Circuit with Load Capacitor**

In Figure 10, the load capacitor has been added before the coupling capacitor. The Norton equivalent is generated as before, and the resistor R1 is combined with the load capacitor C<sub>L</sub> to form the impedance Z<sub>L</sub> = R1/(1 + jωC<sub>L</sub>R1). Using the quantities (3)–(5) as above, it can be shown that

$$H(j\omega) = \frac{C1}{C_T + C1} \bullet$$

$$\frac{-Q_o\gamma^2}{Q_o(1-\gamma^2) + j\gamma + j\omega C_L R1(1-\gamma^2) - \gamma^2\omega_o C_L R1} \quad (6)$$

A quick examination of (6) reveals that the load capacitor adds two terms to the denominator of (1) above. Indeed, if C<sub>L</sub> is sent to 0, the terms for the load capacitor are removed, and the transfer function of (6) reduces to (1).

Equation (6) above can be manipulated to find both the magnitude and phase characteristics of the circuit to be

$$\left|H(j\omega)\right|_{\omega=\omega_o} = \frac{C1Q_o}{C1 + C_L} \bullet \frac{C_L R1\omega_o + 1}{(C_L R1\omega_o)^2 + 1} \quad (7)$$

and

$$\phi(j\omega) = \arctan\left(\frac{\gamma + C_L R1\omega_o(1-\gamma^2)}{\gamma^2 C_L R1 - Q_o(1-\gamma^2)}\right) \quad (8)$$

It is comforting to note that once again, if the terms for  $C_L$  are removed, the transfer function reduces to the conventional tank circuit transfer function [1]. *Figures 11(a)* and *11(b)* show the theoretical and measured transfer functions

for the parallel tank with load capacitor. Component values used were  $C_L = 4.7 \text{ pF}$ ,  $R_1 = 250\Omega$ ,  $C_T = 13.5 \text{ pF}$ ,  $L_T = 150 \text{ nH}$ ,  $R_T = 1000\Omega$ , and  $R_L = 30 \text{ k}\Omega$ .

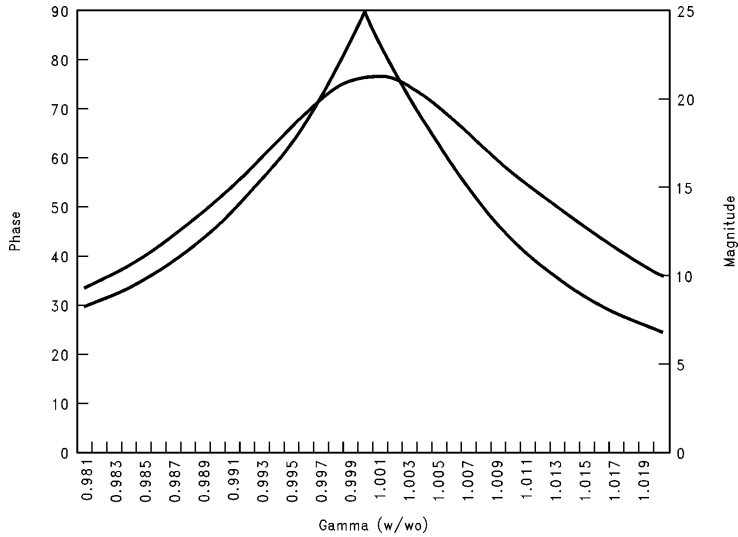

TL/W/12548-13

(a)

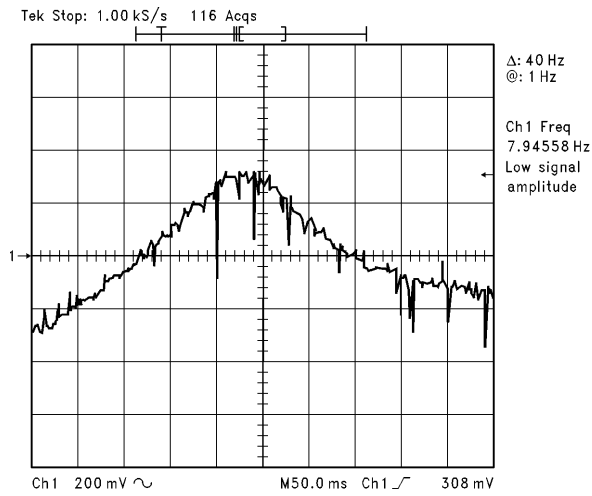

TL/W/12548-14

(b)

**FIGURE 11. Plots of parallel tank circuit with load capacitor 4.7 pF.**  
**(a) Theoretical phase and magnitude**  
**(b) Measured phase characteristic (S-curve). Horiz. - 400 kHz/div., vert. 200 mV/div.**

It can be seen that again, there is good agreement between the theoretical predictions and the measured curves. It is interesting to note that in this case, the tank must actually be tuned off center frequency to give good phase shift, since there is virtually no phase shift at the center frequency. Figure 12 shows the measured S-curve for the same circuit configuration with a larger load capacitor (20 pF).

The phase characteristic has its largest swing near the peak, which means that the tank must be tuned as close as possible to the phase reversal, while keeping enough margin to retain linearity across temperature swings. The fact that the "S-curve" reaches its peak at the center frequency also means that the nominal DC point of the mixer output will be shifted relative to the conventional tank. The demodulated output will be shifted higher than the normal "center" of the mixer's output range. In the LMX2240, this means that the normal 1.5V center voltage for demodulated data is about 1.8V or 1.9V center voltage for the modified parallel tank circuit.

Due to these reasons, this tank circuit is not as desirable as the simple parallel tank. The modified parallel tank (or parallel tank with load capacitor) is only used when other methods to reduce oscillations have been exhausted.

#### SERIES TANK

Until now, the analysis has concentrated on tank circuits that are in parallel with the signal path. These tanks are conventional configurations, and should always be used if enough phase shift can be generated. However, in very narrowband systems, the phase shift from a single conventional tank may not be sufficient for good demodulated signal swing. In these cases, alternate tanks must be examined. In [1], the dual tuned tank circuit is analyzed, and found to give a larger phase shift than the single tank. Its drawback is, of course, it requires two tuned tank circuits. If the designer wishes to keep a single tuned tank circuit configuration, he or she can choose to use what will be termed a "series" tank.

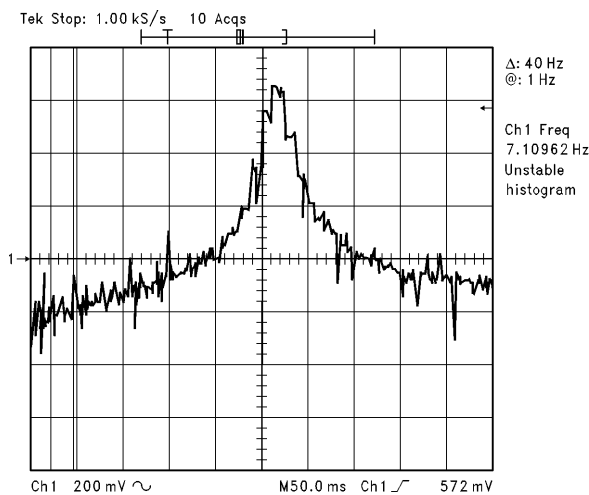

TL/W/12548-15

**FIGURE 12. Plot of measured S-curve for parallel tank with load capacitor = 20 pF. horiz - 2 MHz/div., vert - 200 mV/div.**



The fundamental difference between a “series” tank and a conventional tank is that the resonant circuit is placed in series with the signal path. By keeping the resonant elements in parallel with each other, a band stop magnitude characteristic is formed. The phase shift, however, is large, and this is the desirable quality of the series tank circuit. The revision F LMX2240 Evaluation Board uses a series tank configuration. *Figure 13* shows the series tank configuration.

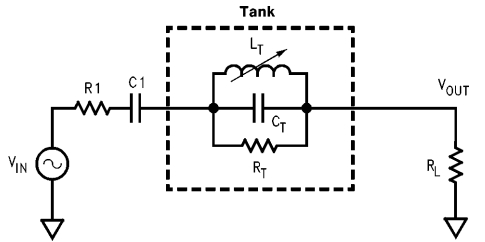

**FIGURE 13. Circuit Diagram of the Series Tank Configuration**

TL/W/12548-16

The first step in analyzing the series tank is to compute the impedances of the tank circuit and the source circuit. The coupling capacitor C1 is combined with the source impedance R1 to form the complex impedance

$$Z1 = \frac{(1 + j\omega C1R1)}{j\omega C1R1} \quad (9)$$

The impedance of the tank circuit is given by

$$Z_T = \frac{j\omega L_T R_T}{R_T(1 - \omega^2 L_T C_T) + j\omega L_T} \quad (10)$$

The transfer function is then given by

$$H(j\omega) = \frac{V_{OUT}}{V_{IN}} = \frac{R_L}{R_L + Z1 + Z_T} = \frac{R_L}{R_L + \frac{1 + j\omega C1R1}{j\omega C1R1} + \frac{j\omega L_T R_T}{R_T(1 - \omega^2 L_T C_T) + j\omega L_T}} \quad (11)$$

With some simplification by using equations (3) through (5) above, (11) reduces to

$$H(j\omega) = \frac{\omega_o \gamma C1 R_L}{\omega_o \gamma C1 (R_L + R1 + R_T) - j} \quad (12)$$

The phase and magnitude characteristics can then be computed. The phase characteristic is

$$\phi(j\omega) = \frac{-1}{\omega_o \gamma C1 (R_L + R1 + R_T)} \quad (13)$$

and the magnitude characteristic squared is

$$|H(j\omega)|^2 = \frac{(\omega_o \gamma C1 R_L)^2}{[\omega_o \gamma C1 (R_L + R1 + R_T)]^2 + 1} \quad (14)$$

*Figures 14(a)* and *14(b)* show the theoretical and measured transfer functions of the series tank circuit. Component values used are C1 = 4.7 pF, R1 = 250Ω, C\_T = 13.5 pF, L\_T = 150 nH, R\_T = 1000Ω, R\_L = 30 kΩ.

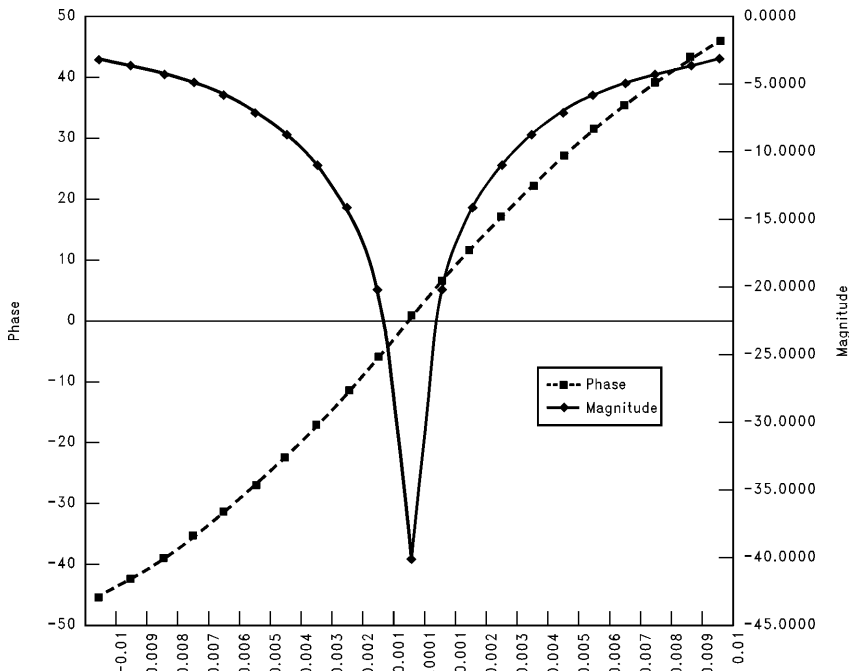

TL/W/12548-17

(a)

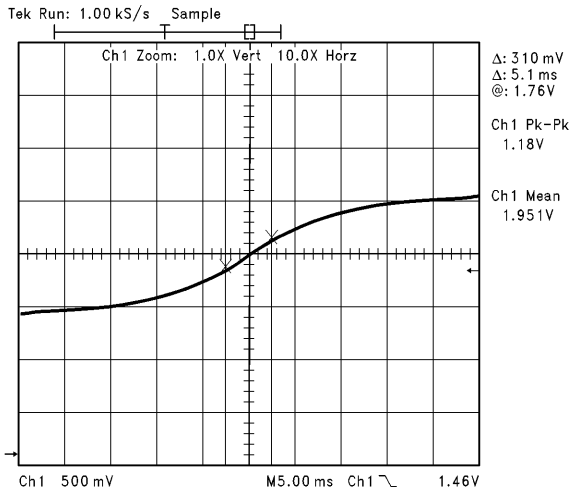

TL/W/12548-18

(b)

FIGURE 14. Plot of series tank circuit. (a) Theoretical phase and magnitude (b) Measured phase characteristic (S-curve). horiz. - 362.5 kHz/div., vert. - 500 mV/div.

It can be seen that there is good agreement between the prediction and the measured results. The demodulated signal has a slightly higher voltage swing than the parallel tank, indicating that the series tank does introduce a larger phase transition across the band of interest. *Figure 15* shows the demodulated 1 kHz tone with 200 kHz peak deviation signal as in the previous cases. It can be seen that the eye diagram is about 25% larger swing for the series tank.

An interesting phenomenon of the series tank is that the phase characteristic actually has two transition points, causing the “S-curve” to take on a “U” shape when a wider frequency sweep is done, as in *Figure 16* below. This may cause problems in production since there are two resonance points. Also, if the tank is tuned to the negative going phase transition, the receive data will be inverted. If production testing is done using S-curves, then the manufacturer can be assured of a positive going phase transition.

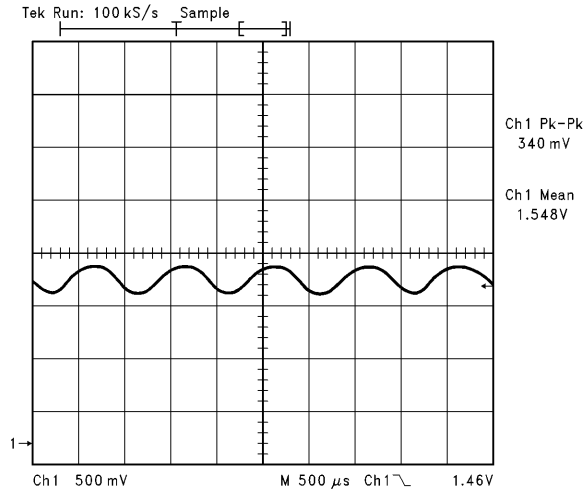

TL/W/12548-19

**FIGURE 15. Plot of Received “Eye Diagram” for 1 kHz Tone with 200 kHz Peak Deviation Using the Series Tank Circuit**

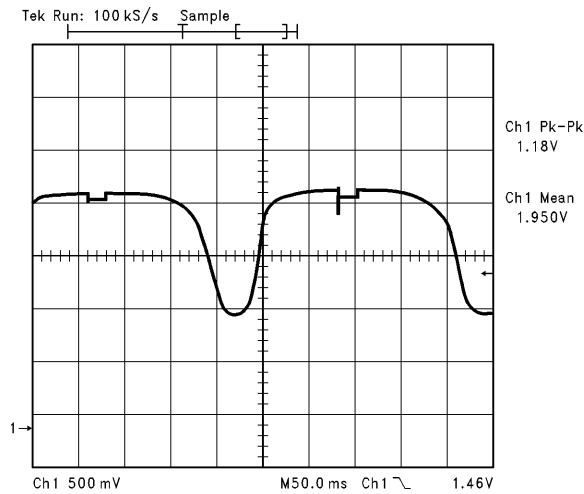

TL/W/12548-20

**FIGURE 16. Plot of series tank “S”-curve (or “U” curve). Horiz. - 3.64 MHz/div., vert. - 500 mV/div.**

**CONCLUSIONS**

The LMX2240 is an ideal choice for high intermediate frequency receivers because of its high gain and wide dynamic range. While oscillation is a concern with such a device, practical methods to reduce the likelihood of oscillation can be implemented with good success. The conventional parallel tank circuit is the tank circuit of choice for most applications. However, a modified parallel tank, a dual tuned tank, or a series tank can be used if the particular application calls for it.

**REFERENCES**

- [1] Edward A. Riehley, "Design of Quadrature Detectors", *RF Design Magazine*, vol. 14, no. 5, May, 1991, pp. 68-72.
- [2] National Semiconductor Corporation, "LMX2240 Intermediate Frequency Receiver Data Sheet", Lit # 108540-002.

**LIFE SUPPORT POLICY**

NATIONAL'S PRODUCTS ARE NOT AUTHORIZED FOR USE AS CRITICAL COMPONENTS IN LIFE SUPPORT DEVICES OR SYSTEMS WITHOUT THE EXPRESS WRITTEN APPROVAL OF THE PRESIDENT OF NATIONAL SEMICONDUCTOR CORPORATION. As used herein:

- 1. Life support devices or systems are devices or systems which, (a) are intended for surgical implant into the body, or (b) support or sustain life, and whose failure to perform, when properly used in accordance with instructions for use provided in the labeling, can be reasonably expected to result in a significant injury to the user.
- 2. A critical component is any component of a life support device or system whose failure to perform can be reasonably expected to cause the failure of the life support device or system, or to affect its safety or effectiveness.



**National Semiconductor Corporation**  
 1111 West Bardin Road  
 Arlington, TX 76017  
 Tel: 1(800) 272-9959  
 Fax: 1(800) 737-7018

<http://www.national.com>

**National Semiconductor Europe**

Fax: +49 (0) 180-530 85 86  
 Email: [europe.support@nsc.com](mailto:europe.support@nsc.com)  
 Deutsch Tel: +49 (0) 180-530 85 85  
 English Tel: +49 (0) 180-532 78 32  
 Français Tel: +49 (0) 180-532 93 58  
 Italiano Tel: +49 (0) 180-534 16 80

**National Semiconductor Hong Kong Ltd.**

19th Floor, Straight Block,  
 Ocean Centre, 5 Canton Rd.  
 Tsimshatsui, Kowloon  
 Hong Kong  
 Tel: (852) 2737-1600  
 Fax: (852) 2736-9960

**National Semiconductor Japan Ltd.**

Tel: 81-043-299-2308  
 Fax: 81-043-299-2408

National does not assume any responsibility for use of any circuitry described, no circuit patent licenses are implied and National reserves the right at any time without notice to change said circuitry and specifications.